

**E.N.T. - Esophagoscopy – Bronchoscopy
Neuro-Endoscopy
Basic Surgery Instruments**

CONTENTS

RHINOLOGY

1 Sinuscope	1
2 Light cable & connector	2
3 Sinuscopy forceps	2-8
4 Maxillary suction tube	8-9
5 Sinuscopy Instruments	9-11
6 Pediatric Sinuscopy Instruments	9
7 WHB-1 Powered drill	12
8 Nasal electric coagulator with suction	13

OTOLOGY

1 Otoscope	13
2 Middle ear forceps 70mm	14
3 Otoscopy instruments	14-18
4 WHC-2 Powered drill	18

LARYNGOLOGY

1 Laryngoscope	19
2 Self-retaining Laryngoscopy set	19-20
3 Laryngoscopy forceps	20-21
4 Mouth-gag	22-23
5 Laryngoscopy Instruments	24-26

BRONCHOLOGY

1 Bronchoscope	26
2 Pediatric bronchoscopy visual tube	27
3 Bronchoscopy instruments	27-29

ESOPHAGUS

1 Esophagoscopy visual tube	29
2 Esophagoscopy instruments	29-30

NEUROSURGERY

1 Neuro-endoscopy instruments	31
-------------------------------	----

BASIC SURGERY INSTRUMENTS

IMAGING & ACCESSORIES

1 Endoscopy imaging	33
2 Optical coupler	34
3 Light source	34
4 Sterilize case for Instruments	34



Sinuscope

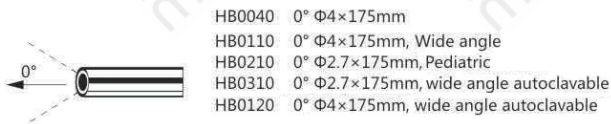

- HB0040 0° Φ 4×175mm
- HB0110 0° Φ 4×175mm, Wide angle
- HB0210 0° Φ 2.7×175mm, Pediatric
- HB0310 0° Φ 2.7×175mm, wide angle autoclavable
- HB0120 0° Φ 4×175mm, wide angle autoclavable



Sinuscope

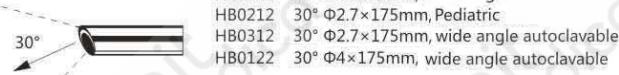

- HB0042 30° Φ 4×175mm
- HB0112 30° Φ 4×175mm, Wide angle
- HB0212 30° Φ 2.7×175mm, Pediatric
- HB0312 30° Φ 2.7×175mm, wide angle autoclavable
- HB0122 30° Φ 4×175mm, wide angle autoclavable

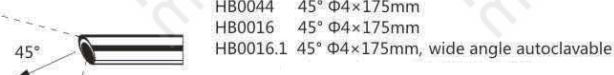

- HB0044 45° Φ 4×175mm
- HB0016 45° Φ 4×175mm
- HB0016.1 45° Φ 4×175mm, wide angle autoclavable



Sinuscope

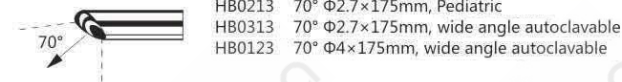

- HB0043 70° Φ 4×175mm
- HB0113 70° Φ 4×175mm, Wide angle
- HB0213 70° Φ 2.7×175mm, Pediatric
- HB0313 70° Φ 2.7×175mm, wide angle autoclavable
- HB0123 70° Φ 4×175mm, wide angle autoclavable

Light cable



WOLF



STORZ

Connecting to cold light source

Connecting to endoscope



WOLF

OLYMPUS
STORZ



OLYMPUS



STRYKER ACMI

- HT5012 Φ 4.5×2000mm
- HT5020 Φ 4.5×2500mm
- HT5021 Φ 4.5×3000mm

Adaptor



HT1003 Adaptor, for WOLF endoscope



HT1004 Adaptor, for WOLF, Cold light source



HT1005 Adaptor, for OLYMPUS cold light source



HT1006 Adaptor, for STRYKER light guide cable



HT1007 Adaptor, for ACMI light guide cable



HT1008 Adaptor, for ACMI, STRYKER endoscope

Sinuscopy Instruments



Sinuscopy Instruments



HB2095
Blade with tooth, straight



HB2096
Blade with tooth, left curved



HB2097
Blade with tooth, right curved



Nasal tissue scissors 120mm



Nasal grasping forceps 105mm
HB2043 downward 90°, open to back 120°
HB2043.2 Upward 90°, open to back 120°



Nasal grasping forceps 105mm
HB2043.1 Long curved, downward 115°
HB2043.3 Long curved, upward 115°



Nasal tissue forceps (0°/105mm)
HB2100 Sharp head
HB2100.1 (L)
HB2100.2 (S)
HB2100M Sharp head 130mm



Nasal tissue forceps (30°/105mm)
HB2101 Sharp head
HB2101.1 (L)
HB2101.2 (S)



Nasal tissue forceps
(sharp head) (105mm)
HB2102 45°
HB2103 90°



Polyp forceps of nasal cavity (0°/105mm)
HB2104 Round head



HB2098
Nasal rongeur front-biting
(105mm)



B2099
HBack biting rongeur
HB2099M 130mm
HB2099.1 left opening
HB2099.2 right opening



Cutting forceps of nasal
ethmoid (0°/105mm)
HB2094.1 0°
HB2094.5 Left-biting
HB2094.6 Right-biting



Cutting forceps of nasal ethmoid
(30°/105mm)
HB2094.2 30°
HB2094.7 Left-biting
HB2094.8 Right-biting
HB2094.9 45° Right-biting
HB2094.10 45°



HB2095.1
Nasal tissue scissors
Straight (105mm)



Nasal tissue scissors
(105mm)
HB2096.1 Left-curved
HB2097.1 Right-curved



Tissue forceps of nasal cavity
with suction tube (105mm) 0°
HB2039 (L)
HB2039.1 (M)



Tissue forceps of nasal cavity
with suction tube (105mm) 30°
HB2040 (L)
HB2040.1 (M)



Tissue forceps of nasal cavity
with suction tube (105mm) 45°
HB2041 (L)
HB2041.1 (M)



Tissue forceps of nasal cavity
with suction tube (105mm) 90°
HB2042 (L)
HB2042.1 (M)



HB2080
Open forceps of nasal
ethmoid Flat head (105mm)



HB2081
Open forceps of nasal
ethmoid Up head (105mm)



Open forceps of nasal
ethmoid Sharp head (105mm)
HB2082 (L)
HB2082.1 (S)



HB2085
Nasal-pharyngeal biopsy
forceps Straight (150mm)



HB2086
Nasal-pharyngeal biopsy
forceps (150mm)



HB2086.1
Nasal-pharyngeal biopsy
forceps Upward (150mm) 70°



HB2087
Nasal-pharyngeal biopsy
forceps Curved (180mm)



HB2022
Nasal polyp ethmoid forceps
Round head (130mm)



HB2023
Nasal polyp ethmoid forceps
Sharp head (130mm)



HB2099.9
Suture removing forceps



HB2099.10
Foreign body forceps



HB2099.3
Back biting rongeur
Down curved (105mm)

Sinuscopy Instruments



HB2514
Nasal tissue forceps, front biting
0°/105mm



HB2515
Nasal tissue forceps, front biting
sharp (small) 0°/105mm



HB2516
Nasal tissue forceps, front biting
sharp (small) 30°/105mm



Nasal tissue forceps,
front biting sharp (small)
45°/105mm
HB2516.1



Nasal tissue forceps,
without fixed pin (0°/105mm)
HB2517.1 Large
HB2517.2 Middle
HB2517.3 Small



Nasal tissue forceps,
without fixed pin (45°/105mm)
HB2519.1 Large
HB2519.2 Small



HB9100
Tissue forceps of nasal cavity sharp
head, without fixed pin (0°/105mm)



HB9101
Tissue forceps of nasal cavity
sharp head, without fixed pin
(30°/105mm)



HB9102
Tissue forceps of nasal cavity
sharp head, without fixed pin
(45°/105mm)



HB9103
Tissue forceps of nasal cavity
sharp head, without fixed pin
(90°/105mm)



HB9104
Tissue forceps of nasal cavity
round head, without fixed pin
(0°/105mm)



HB9094.1
Rongeur of nasal ethmoid
(0°/105mm)



HB9094.2
Rongeur of nasal ethmoid
(30°/105mm)



Nasal tissue cutting forceps (140mm)
HB2010.1 0° sharp head(L)
HB2010.2 0° sharp head(S)



Nasal tissue cutting forceps (140mm)
HB2011.1 30° sharp head(L)
HB2011.2 30° sharp head(S)



Nasal tissue cutting forceps (140mm)
HB2012.1 45° sharp head(L)
HB2012.2 45° sharp head(S)



Nasal tissue cutting forceps (140mm)
HB2013.1 0° round head(L)
HB2013.2 0° round head(S)



Nasal tissue cutting forceps (140mm)
HB2014.1 30° round head(L)
HB2014.2 30° round head(S)



Nasal tissue cutting forceps (140mm)
HB2015.1 45° round head(L)
HB2015.2 45° round head(S)



Sinuscopy Instruments



HB2513
Back biting rongeur
Rotatable 360°



Detachable rongeur Rotatable



HB2301 60° 4mm
HB2301.2 60° 3.5mm
HB2301.4 60° 3mm



HB2301.1 90° 4mm
HB2301.3 90° 3.5mm
HB2301.5 90° 3mm



Multi-functional rongeur
Rotatable



HB2300 60° 4mm
HB2300.2 60° 3.5mm



HB2300.1 90° 4mm
HB2300.3 90° 3.5mm



Side cutting forceps
HB2522 left biting
HB2523 right biting



Nasal bipolar forceps
Use with B1007 high frequency cord
HB2125 0°
HB2125.1 Upward 20°



Detachable suction polyp forceps 0°
HB2162.1 $\Phi 5 \times 140$ mm
HB2162.2 $\Phi 4 \times 140$ mm
HB2162.3 $\Phi 3 \times 140$ mm



Sphenoidal sinus enlarge forceps



HB2160 0° $\Phi 3.5 \times 180$ mm
HB2161 0° $\Phi 4.5 \times 180$ mm



HB2160.1 30° $\Phi 3.5 \times 180$ mm
HB2161.1 30° $\Phi 4.5 \times 180$ mm



HB2001
Optical forceps 0°/150mm



HB2003
Optical forceps 70°/120mm



HB2002
Optical forceps, flexible 30°/120mm

Sinuscopy Instruments

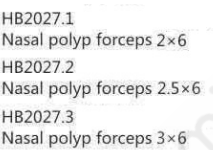
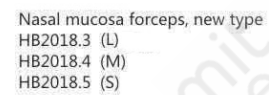

Sinuscopy Instruments



HB2099.8
Grasping forceps, three teeth



Nasal rongeur, sharp head 100mm



Nasal tissue cutting forceps 2mm
HB2530 0° B2531 30°
HB2532 45° B2533 90°



HB2534 0° HB2535 30° HB2536 45°



HB2030
Nasal stamping forceps 180mm



HB2057
Maxillary retractor
HB2057.1
Maxillary retractor 165mm



HB2071
Nasal bone resetting forceps



HB1001
Adult nasal speculum 30mm
HB1002
Pediatric nasal speculum 20mm



HB1001.2
Adult nasal speculum 30mm



HB1003
Operation nasal speculum 50mm



HB2032
Nasal mouth gag



HB2024
Nasal polyp snare



HB2126.3
Nasal suction & irrigation sheath



HB2058
Maxillary trocar

Sinuscopy Instruments



HB2077
Nosepiece scissors
Upperbound

HB2078
Nosepiece scissors
Middlebound

HB2079
Nosepiece scissors
Lowerbound

Maxillary suction tube



Maxillary suction tube
HB2115 $\Phi 3 \times 125\text{mm}$
HB2115.1 $\Phi 4 \times 125\text{mm}$
HB2115.2 $\Phi 2.5 \times 125\text{mm}$
HB2169 $\Phi 3 \times 125\text{mm}$ curved flexible
HB2169.1 $\Phi 4 \times 145\text{mm}$ curved flexible

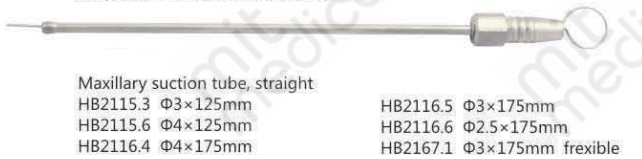

Maxillary suction tube, straight
HB2115.3 $\Phi 3 \times 125\text{mm}$
HB2115.6 $\Phi 4 \times 125\text{mm}$
HB2116.4 $\Phi 4 \times 175\text{mm}$
HB2116.5 $\Phi 3 \times 175\text{mm}$
HB2116.6 $\Phi 2.5 \times 175\text{mm}$
HB2167.1 $\Phi 3 \times 175\text{mm}$ flexible



Maxillary suction tube $\Phi 3 \times 125\text{mm}$
HB2115.4 Square handle
HB2115.5 Straight handle

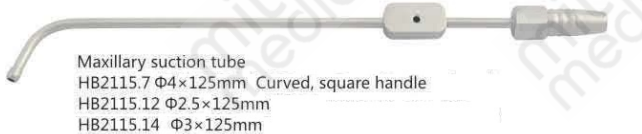

Maxillary suction tube
HB2115.7 $\Phi 4 \times 125\text{mm}$ Curved, square handle
HB2115.12 $\Phi 2.5 \times 125\text{mm}$
HB2115.14 $\Phi 3 \times 125\text{mm}$

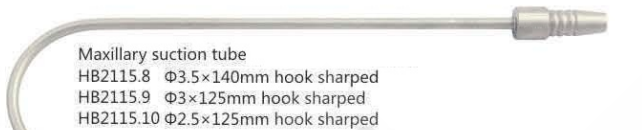

Maxillary suction tube
HB2115.8 $\Phi 3.5 \times 140\text{mm}$ hook sharpened
HB2115.9 $\Phi 3 \times 125\text{mm}$ hook sharpened
HB2115.10 $\Phi 2.5 \times 125\text{mm}$ hook sharpened



HB2115.20
Maxillary suction tube $\Phi 2.5 \times 140\text{mm}$



HB2115.21
Maxillary suction tube $\Phi 2.5 \times 125\text{mm}$



Maxillary suction tube square handle
HB2115.12 $\Phi 2.5 \times 125\text{mm}$
HB2115.15 $\Phi 2.5 \times 125\text{mm}$
HB2115.16 $\Phi 2.5 \times 105\text{mm}$ Straight
HB2115.18 $\Phi 4.0 \times 105\text{mm}$ Straight
HB2115.13 $\Phi 4.0 \times 125\text{mm}$
HB2115.17 $\Phi 3.0 \times 105\text{mm}$ Straight



Suction tube, curved 175mm
HB2116 $\Phi 3.5\text{mm}$ B2116.1 $\Phi 4\text{mm}$
HB2116.2 $\Phi 3\text{mm}$ B2116.3 $\Phi 2.5\text{mm}$
HB2166 $\Phi 4\text{mm}$ B2167 $\Phi 3\text{mm}$
HB2168 $\Phi 2.5\text{mm}$



Suction tube, curved, long handle 175mm
HB2116.7 $\Phi 4\text{mm}$
HB2116.8 $\Phi 3\text{mm}$
HB2116.9 $\Phi 2.5\text{mm}$



Suction tube, curved, square handle 150mm
HB2116.10 $\Phi 4\text{mm}$
HB2116.11 $\Phi 3\text{mm}$
HB2116.12 $\Phi 2.5\text{mm}$



Suction tube, head with protection
HB2116.13 $\Phi 2.5\text{mm}$
HB2116.14 $\Phi 3.0\text{mm}$
HB2116.15 $\Phi 3.5\text{mm}$
HB2116.16 $\Phi 4.0\text{mm}$



HB2116.20
Suction tube $\Phi 3 \times 145\text{mm}$



Elevator, with suction
HB2117.1 $\Phi 3\text{mm}$
HB2117.2 $\Phi 4\text{mm}$



Hb2088 $\Phi 3; \Phi 3 \times 125\text{mm}$
HB2088.1 $\Phi 3; \Phi 2 \times 125\text{mm}$
HB2088.2 $\Phi 2.5; \Phi 2 \times 125\text{mm}$
Suction & irrigation tube, double tube



HB2510
Nasal irrigation tube, curved $\Phi 2 \times 180\text{mm}$

Maxillary suction tube



Nasal mastoid suction tube, straight $\Phi 5 \times 195$ mm
 HB2511.1 $\Phi 5$ mm
 HB2511.2 $\Phi 4$ mm
 HB2511.3 $\Phi 3$ mm

Nasal mastoid suction tube, curved $\Phi 5 \times 195$ mm
 HB2512.1 $\Phi 5$ mm
 HB2512.2 $\Phi 4$ mm
 HB2512.3 $\Phi 3$ mm

Adaptor, for suction tube
 HB2170 For long connector
 HB2171 For short connector
 HB2172 For peanut connector
 HB2173 For peanut connector, S type

Suction tube for treatment table, short connector
 HB2171.1 $\Phi 1.5$ mm
 HB2171.2 $\Phi 2$ mm
 HB2171.3 $\Phi 2.5$ mm
 HB2171.4 $\Phi 3$ mm
 HB2171.5 $\Phi 3.5$ mm

Suction tube for treatment table, long connector
 HB2170.1 $\Phi 1.5$ mm HB2170.2 $\Phi 2$ mm
 HB2170.3 $\Phi 2.5$ mm HB2170.4 $\Phi 3$ mm
 HB2170.5 $\Phi 3.5$ mm

Suction tube for treatment table, peanut connector, S type
 HB2173.1 $\Phi 1.5$ mm
 HB2173.2 $\Phi 2$ mm
 HB2173.3 $\Phi 2.5$ mm
 HB2173.4 $\Phi 3$ mm
 HB2173.5 $\Phi 3.5$ mm

Suction tube for treatment table, peanut connector
 HB2172.1 $\Phi 1.5$ mm HB2172.2 $\Phi 2$ mm
 HB2172.3 $\Phi 2.5$ mm HB2172.4 $\Phi 3$ mm
 HB2172.5 $\Phi 3.5$ mm

Sinuscopy Instruments

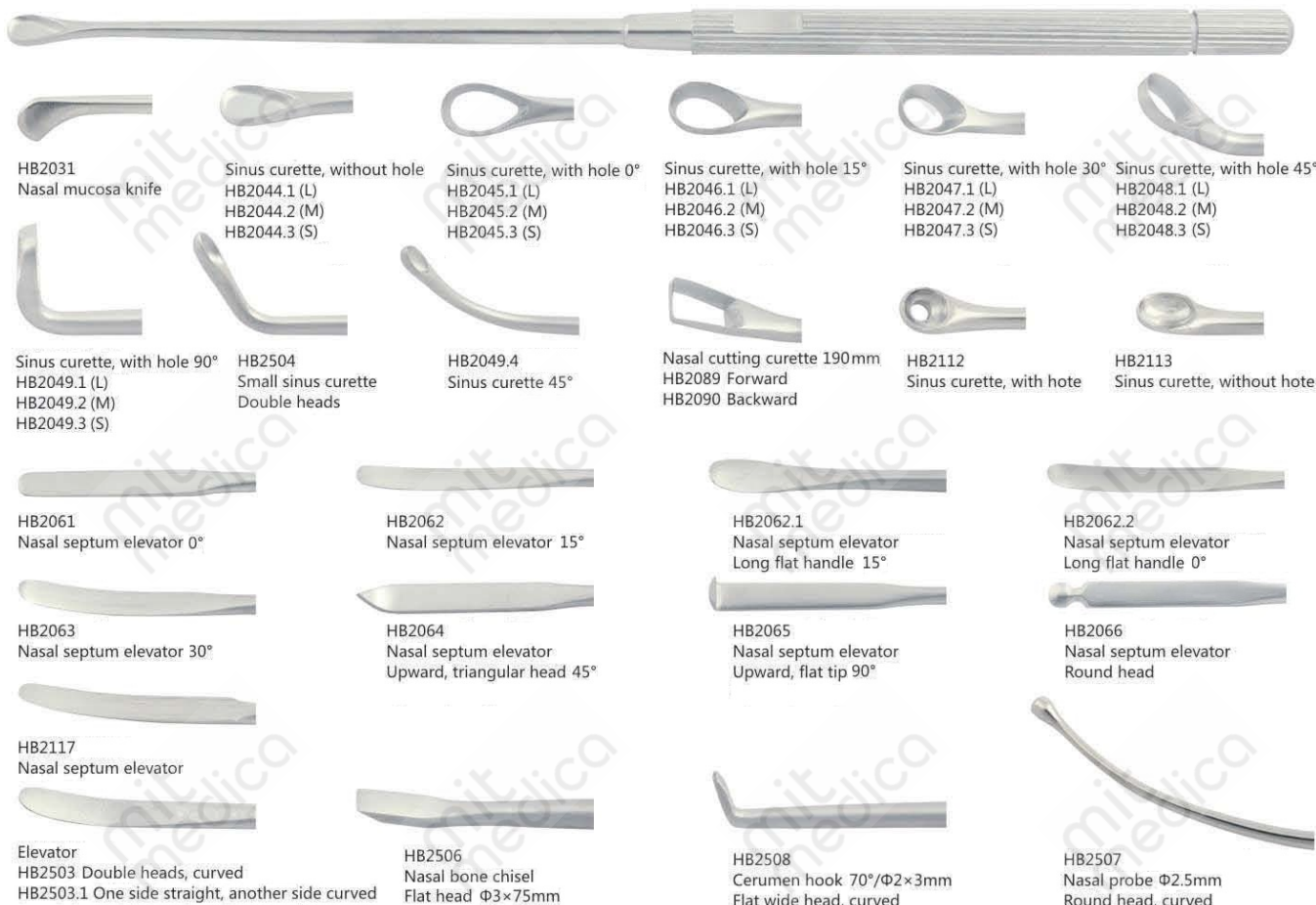

HB2031
Nasal mucosa knife

Sinus curette, without hole
 HB2044.1 (L)
 HB2044.2 (M)
 HB2044.3 (S)

Sinus curette, with hole 0°
 HB2045.1 (L)
 HB2045.2 (M)
 HB2045.3 (S)

Sinus curette, with hole 15°
 HB2046.1 (L)
 HB2046.2 (M)
 HB2046.3 (S)

Sinus curette, with hole 30°
 HB2047.1 (L)
 HB2047.2 (M)
 HB2047.3 (S)

Sinus curette, with hole 45°
 HB2048.1 (L)
 HB2048.2 (M)
 HB2048.3 (S)

Sinus curette, with hole 90°
 HB2049.1 (L)
 HB2049.2 (M)
 HB2049.3 (S)

HB2504
Small sinus curette
Double heads

HB2049.4
Sinus curette 45°

Nasal cutting curette 190mm
 HB2089 Forward
 HB2090 Backward

HB2112
Sinus curette, with hole

HB2113
Sinus curette, without hole

HB2061
Nasal septum elevator 0°

HB2062
Nasal septum elevator 15°

HB2062.1
Nasal septum elevator
Long flat handle 15°

HB2062.2
Nasal septum elevator
Long flat handle 0°

HB2063
Nasal septum elevator 30°

HB2064
Nasal septum elevator
Upward, triangular head 45°

HB2065
Nasal septum elevator
Upward, flat tip 90°

HB2066
Nasal septum elevator
Round head

HB2117
Nasal septum elevator

Elevator
 HB2503 Double heads, curved
 HB2503.1 One side straight, another side curved

HB2506
Nasal bone chisel
Flat head $\Phi 3 \times 75$ mm

HB2508
Cerumen hook 70°/ $\Phi 2 \times 3$ mm
Flat wide head, curved

HB2507
Nasal probe $\Phi 2.5$ mm
Round head, curved

Sinuscopy Instruments



Nasal septum elevator
HB2067 Double heads, curved
HB2067.1 One side straight, another side curved



HB2067.2 Nasal foreign body hook & ring



HB2067.3 Nasal septum elevator
Half round knife, double heads



HB2505 Sinus operation knife Double heads



Elevator suction tube



HB2502.1 $\Phi 3.5 \times 75\text{mm}$
HB2502.6 $\Phi 3.5 \times 145\text{mm}$
HB2502.11 $\Phi 3.5 \times 75\text{mm}$



HB2502.2 $\Phi 2.5 \times 60\text{mm}$
HB2502.10 $\Phi 2.5 \times 60\text{mm}$



Nasal septum fish tail chisel, straight
HB2059.1 (L)
HB2059.2 (M)
HB2059.3 (S)



Nasal septum fish tail chisel, bayonet shaped
HB2060.1 (L)
HB2060.2 (M)
HB2060.3 (S)



Nasal bone chisel



HB2075
Nasal bone chisel
Flat, curved



Double protection
HB2072.1 6mm
HB2072.2 8mm



Left protection
HB2073.1 6mm
HB2073.2 8mm



Right protection
HB2074.1 6mm
HB2074.2 8mm



HB2076
Nasal bone chisel
Bayonet shaped, half round



HB2031.1
Nasal cartilage knife, double heads 190mm



HB2070 Nasal bone restorer



HB2031.2
Nasal cartilage knife, double heads



HB2070.1 Nasal bone restorer

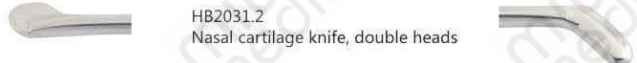

HB2127
Nasal rasp, double sides rasp 6x42mm



HB2120
Trocar $\Phi 4.2 \times 100\text{mm}$



HB2127
Nasal rasp, double sides rasp 6x42mm



HB2163
Maxillary retractor 180mm,
Double heads



HB2121
Endoscope holder



Sickle knife



HB2220
Nasal probe



HB2118 Sharp head curved



HB2119 Blunt head curved

Sinuscopy Instruments



Nasal septum swivel knife, straight
HB2068.1 3mm
HB2068.2 4mm
HB2068.3 5mm

Nasal septum swivel knife, tip, straight
HB2068.4 3mm
HB2068.5 4mm
HB2068.6 5mm



Nasal septum swivel knife, bayonet
HB2069.1 3mm
HB2069.2 4mm
HB2069.3 5mm



Barnhill adenoid curette, without hook
HB2091.1 (L)
HB2091.2 (M)
HB2091.3 (S)



Barnhill adenoid curette, with hook
HB2092.1 (L)
HB2092.2 (M)
HB2092.3 (S)

Pediatric Sinuscopy Instruments



HB2201



Pediatric optical forceps $\Phi 3\text{mm}$
HB2201 0°
HB2202 30°
HB2203 70°



HB2203



HB2205 Straight



HB2206 Left-curved



HB2207 Right-curved

Nasal tissue scissors
 $\Phi 3 \times 110\text{mm}$



Tissue forceps of nasal cavity
HB2039.2 0° HB2041.2 70°
HB2040.2 30° HB2042.2 90°



HB2094.3
Cutting forceps of nasal
ethmoid(S) 0°



HB2094.4
Cutting forceps of nasal
ethmoid(S) 30°



HB2209
Tissue forceps of nasal cavity,
Sharp head 0°/95mm



HB2210
Tissue forceps of nasal cavity,
Sharp head 30°/95mm



HB2211
Tissue forceps of nasal cavity,
Sharp head 45°/95mm



HB2212
Tissue forceps of nasal cavity,
Sharp head 90°/95mm



HB2208
Sinus rongeur, back-biting
95mm



HB2213
Tissue forceps of nasal cavity,
round head 0°



Hb2214
Tissue forceps of nasal cavity,
round head 30°

WHB-1 Powered drill

HB5001 Console

HB5002 Foot Switch

HB3007 Shaver handpiece



Cutters & burs



HB3005.1
Oblique with tooth Φ 4mm



HB3005.2
Oblique without tooth Φ 4mm



HB3005.3
Flat with tooth inside & outside Φ 4mm



HB3005.4
Ball shaped Φ 4mm



HB3005.23
Oblique with tooth Φ 4.5mm



HB3005.24
Oblique without tooth Φ 4.5mm



HB3005.25
Flat with tooth inside & outside Φ 4.5mm



Cutters



Oblique with tooth on obverse side Φ 4.5mm
HB3005.5 20°
HB3005.7 40°
HB3005.9 60°
HB3005.11 75°
HB3005.13 20° Φ 4.0mm



Oblique with tooth on inverse side Φ 4.5mm
HB3005.6 20°
HB3005.8 40°
HB3005.10 60°
HB3005.12 75°
HB3005.14 20° Φ 4.0mm



HB3003 Irrigation needle

Nasal electric coagulator with suction tube



Elevator suction tube, use with M1002
HB2501 $\Phi 4 \times 100\text{mm}$
HB2501.1 $\Phi 3.5 \times 100\text{mm}$



Nasal electric coagulator with suction, flat, use with M1002
HB2122 $\Phi 3\text{mm}$
HB2122.4 $\Phi 4\text{mm}$



HB2122.8
Nasal electric coagulator elevator with suction
Slightly curved $\Phi 3.4 \times 130\text{mm}$



Nasal electric coagulator with suction, flat, bipolar, use with B1006 170mm/0°
HB2124 $\Phi 4\text{mm}$
HB2124.3 $\Phi 3\text{mm}$
HB2124.5 $\Phi 5\text{mm}$



Nasal electric coagulator with suction, flat, bipolar, use with B1006 170mm
HB2124.1 $\Phi 4\text{mm}$ 15°
HB2124.4 $\Phi 3\text{mm}$ 15°
HB2124.7 $\Phi 5\text{mm}$ 15°



Nasal electric coagulator with suction, flat, use with M1002
Flat $\Phi 3\text{mm}$ Flat $\Phi 4\text{mm}$
HB2122.2 60°
HB2122.3 90°
HB2122.6 60°
HB2122.7 90°



Nasal electric coagulator with suction, flat, use with M1002
HB2122.1 50° $\Phi 3\text{mm}$
HB2122.5 50° $\Phi 4\text{mm}$
HB2123.1 45° $\Phi 3\text{mm}$
HB2123.2 45° $\Phi 4\text{mm}$



HB1006
High frequency cord, bipolar



Nasal electric coagulator with suction, flat, bipolar, curved, use with B1006 170mm
HB2124.2 $\Phi 4\text{mm}$ 45°
HB2124.6 $\Phi 5\text{mm}$ 45°

Otoscope

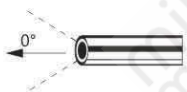

- | | |
|-----------|---|
| HC0010 | 0° $\Phi 7 \times 105\text{mm}$ |
| HC0010.1b | 0° $\Phi 3 \times 90\text{mm}$ |
| HC0010.1c | 0° $\Phi 3.3 \times 90\text{mm}$ Wireless light source |
| HC0010.1d | 0° $\Phi 2.7 \times 60\text{mm}$ |
| HC0020 | 0° $\Phi 2.7 \times 45\text{mm}$ |
| HC0030 | 0° $\Phi 4 \times 45\text{mm}$ |
| HC0010.1 | 0° $\Phi 2.7 \times 107.5\text{mm}$ 2bar 134°C Autoclavable |
| HC0030.1 | 0° $\Phi 4 \times 45\text{mm}$ 2bar 134°C Autoclavable |



- | | |
|----------|--|
| HC0012 | 30° $\Phi 2.7 \times 105\text{mm}$ |
| HC0022 | 30° $\Phi 2.7 \times 45\text{mm}$ |
| HC0032 | 30° $\Phi 4 \times 45\text{mm}$ |
| HC0012.1 | 30° $\Phi 2.7 \times 107.5\text{mm}$ 2bar 134°C Autoclavable |
| HC0032.1 | 30° $\Phi 4 \times 45\text{mm}$ 2bar 134°C Autoclavable |



- | | |
|----------|--|
| HC0013 | 70° $\Phi 2.7 \times 105\text{mm}$ |
| HC0023 | 70° $\Phi 2.7 \times 45\text{mm}$ |
| HC0033 | 70° $\Phi 4 \times 45\text{mm}$ |
| HC0013.1 | 70° $\Phi 2.7 \times 107.5\text{mm}$ 2bar 134°C Autoclavable |
| HC0033.1 | 70° $\Phi 4 \times 45\text{mm}$ 2bar 134°C Autoclavable |

1. Connecting to OLYMPUS light guide cable
Connecting to STORZ light guide cable
2. Connecting to WOLF light guide cable
3. Connecting to ACMI STRYKER light guide cable



Middle ear forceps 70mm



Otology instruments



Otoscopy instruments

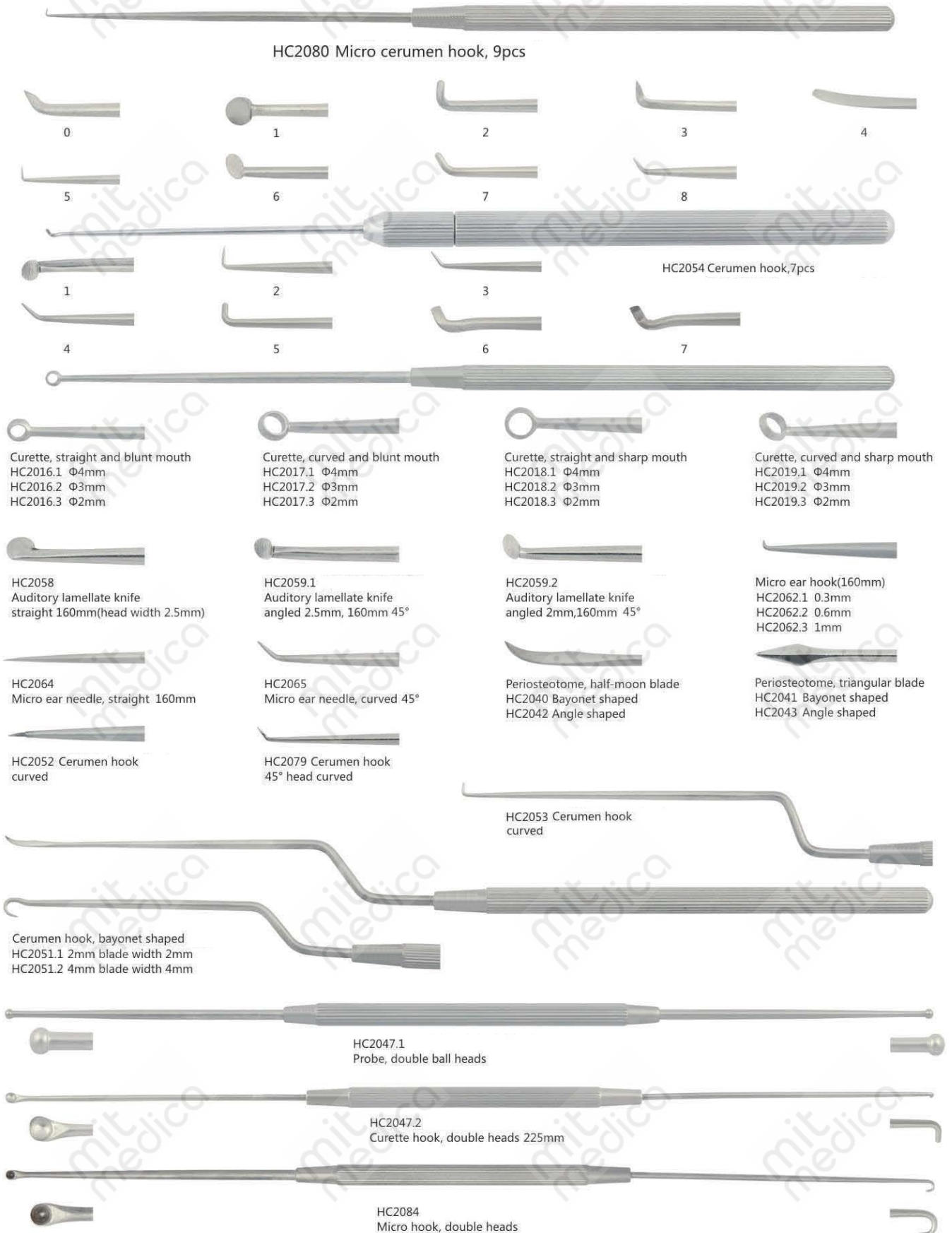

Otoscopy instruments



HC2056
Headlight
Light spot adjustable



HC2056.3
Headlight
LED High light with charger



HC2056.4
Headlight
LED High light



HC2056.2
Light guide cable for
headlight $\Phi 3 \times 2500\text{mm}$



HT5010
Light guide cable
 $\Phi 4.5 \times 2000\text{mm}$



Plester self retaining retractors
HC2038 130mm
HC2038.1 Single tooth



Backman laminectomy retractors
HC2039 160mm
HC2039.1 Single tooth



HC2044
Polyp scissors 140mm



HC2045
Polyp snare



HC2010
Beyer bone rongeur



Mastoid rongeur forceps, single joint
HC2011 Sharp head
HC2011.1 Sharp head, curved 140mm
HC2012 Round head



HC1001 Otoscope sheath



HC2077
Suction head $\Phi 1.5 \times 30\text{mm}$

Otology instruments



Mastoid rongeur forceps, bayonet shaped 90mm
 HC2008.1 Head width 6mm
 HC2008.2 Head width 5mm
 HC2008.3 Head width 4mm

Mastoid hemostatic forceps, bayonet shaped 90mm
 HC2008.5 Head width 5mm
 HC2008.6 Head width 4mm

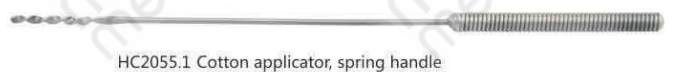
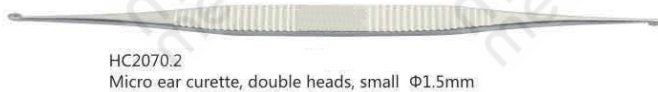

Otoscopy instruments

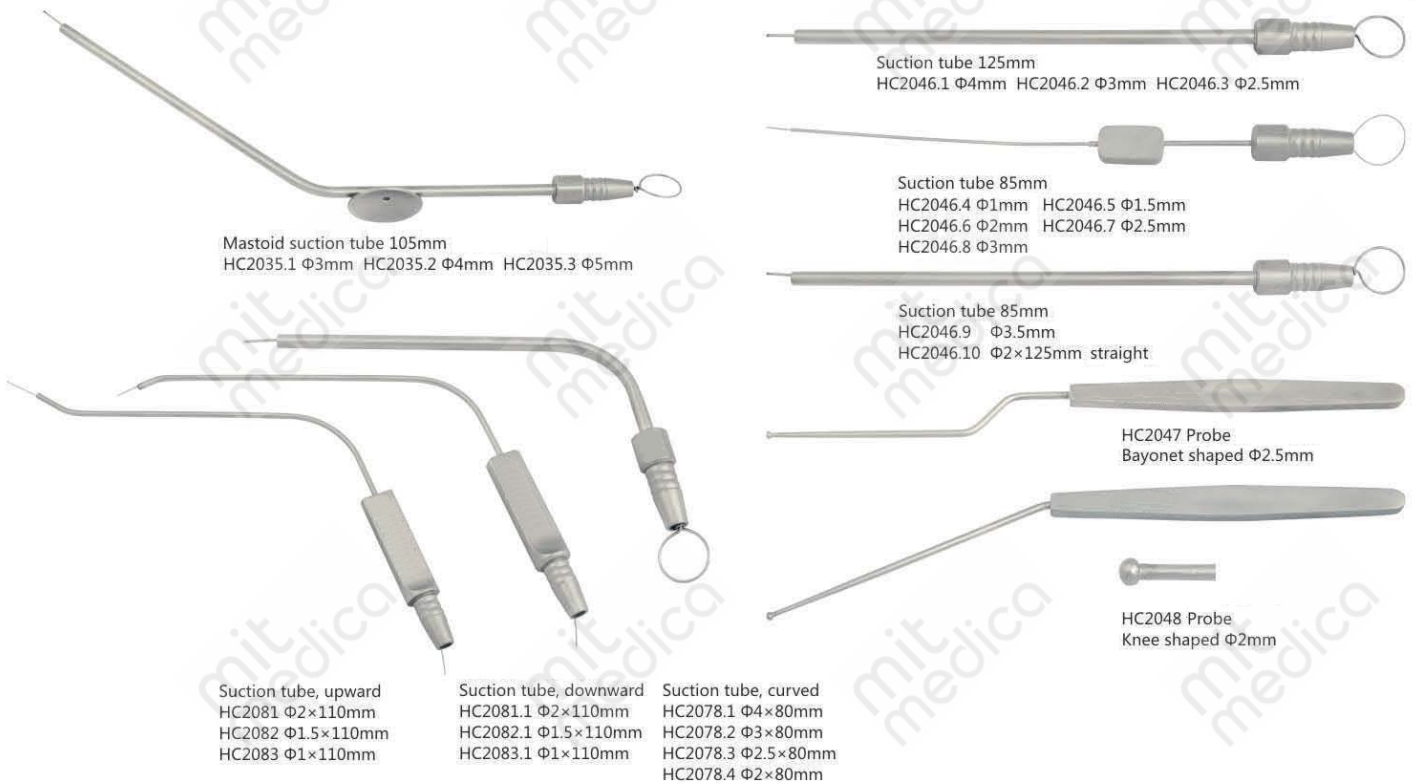

WHC-2 Powered drill



Laryngoscope

1. Connecting to OLYMPUS light guide cable
Connecting to STORZ light guide cable
2. Connecting to WOLF light guide cable
3. Connecting to ACMI STRYKER light guide cable



Self-retaining laryngoscopy set

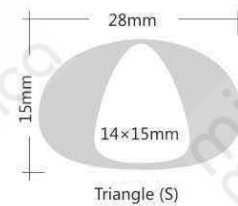
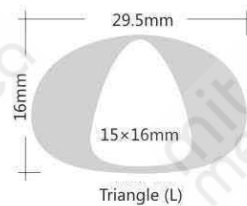
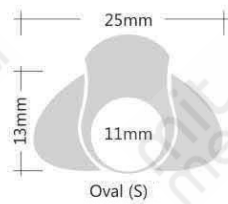
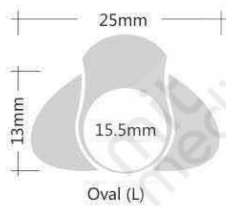

Laryngoscope tube
HD1011 (L) 175mm
HD1012 (S) 175mm



Laryngoscope tube
for 12° endoscope
HD1013.1 (L) 175mm
HD1014.1 (S) 175mm
Laryngoscope tube
for 0° endoscope
HD1013 (L) 175mm
HD1014 (S) 175mm



Laryngoscope tube
HD1003 (L) 175mm
HD1004 (S) 175mm



Laryngoscope tube, for D2083
HD1001 大(L) 170mm
HD1002 小(S) 170mm



Laryngoscope tube
HD2101 (L) 150mm
HD2102 (S) 130mm



Laryngoscope tube
HD2103 (L) 11×150mm
HD2104 (S) 11×130mm



Direct laryngoscope tube
HD2076.1 (L) 16×175mm
HD2076.2 (M) 14×175mm
HD2076.3 (S) 12×175mm



Lateral laryngoscope tube
HD2077.1 (L) 16×175mm
HD2077.2 (M) 14×150mm
HD2077.3 (S) 12×100mm

Self-retaining laryngoscopy set







Laryngoscopy Instruments















Laryngoscopy forceps

230mm Direct laryngeal forceps



			
HD2045 Crocodile head	HD2048 45° Upward	HD2046 Left kidney shaped	
			
HD2049 Triangular head	HD2050 Upward/Triangular head 45°	HD2051 Cup head	

Cup head 30°
 HD2085.1 Ø5mm
 HD2085.2 Ø4mm
 HD2085.3 Ø3mm

Micro-Laryngeal forceps

					
HD4001 Micro-Laryngeal, straight biopsy	HD4002 Micro-Laryngeal 30° biopsy	HD4003 Micro-Laryngeal, left curved biopsy	HD4004 Micro-Laryngeal, right curved biopsy		
					
HD4005 Micro-Laryngeal, left curved 70° biopsy	HD4006 Micro-Laryngeal, right curved 70° biopsy	HD4007 Micro-Laryngeal, left curved 70° grasper	HD4008 Micro-Laryngeal, right curved 70° grasper		
					
HD4009 Micro-Laryngeal, triangular head, biopsy 0°	HD4010 Micro-Laryngeal, triangular head 45° biopsy	HD4011 Micro-Laryngeal, left curved biopsy	HD4012 Micro-Laryngeal, right curved biopsy		
					
HD4014 Micro-Laryngeal scissor, straight	HD4015 Micro-Laryngeal scissor, left curved	HD4016 Micro-Laryngeal scissor, right curved	HD4017 Micro-Laryngeal scissor 15°	HD4018 Micro-Laryngeal scissor 45°	HD4019 Micro-Laryngeal needle holder

Laryngeal foreign body forceps

			
HD3001 270mm open to up HD3002 270mm open to down HD3003 270mm open to left HD3004 270mm open to right	HD3005 Head upward 45°, Cup head HD3005.1 Stick upward 15°, Head upward 45°	HD3006 Head upward 45° 250mm HD3006.1 Stick up-curved 15°, Head upward 45° 250mm	
	HD3006.3 Head upward 45°, Triangle 250mm		

Laryngoscopy Instruments

HD2084.1
Chest protector (elevation type)



Mouth-gag

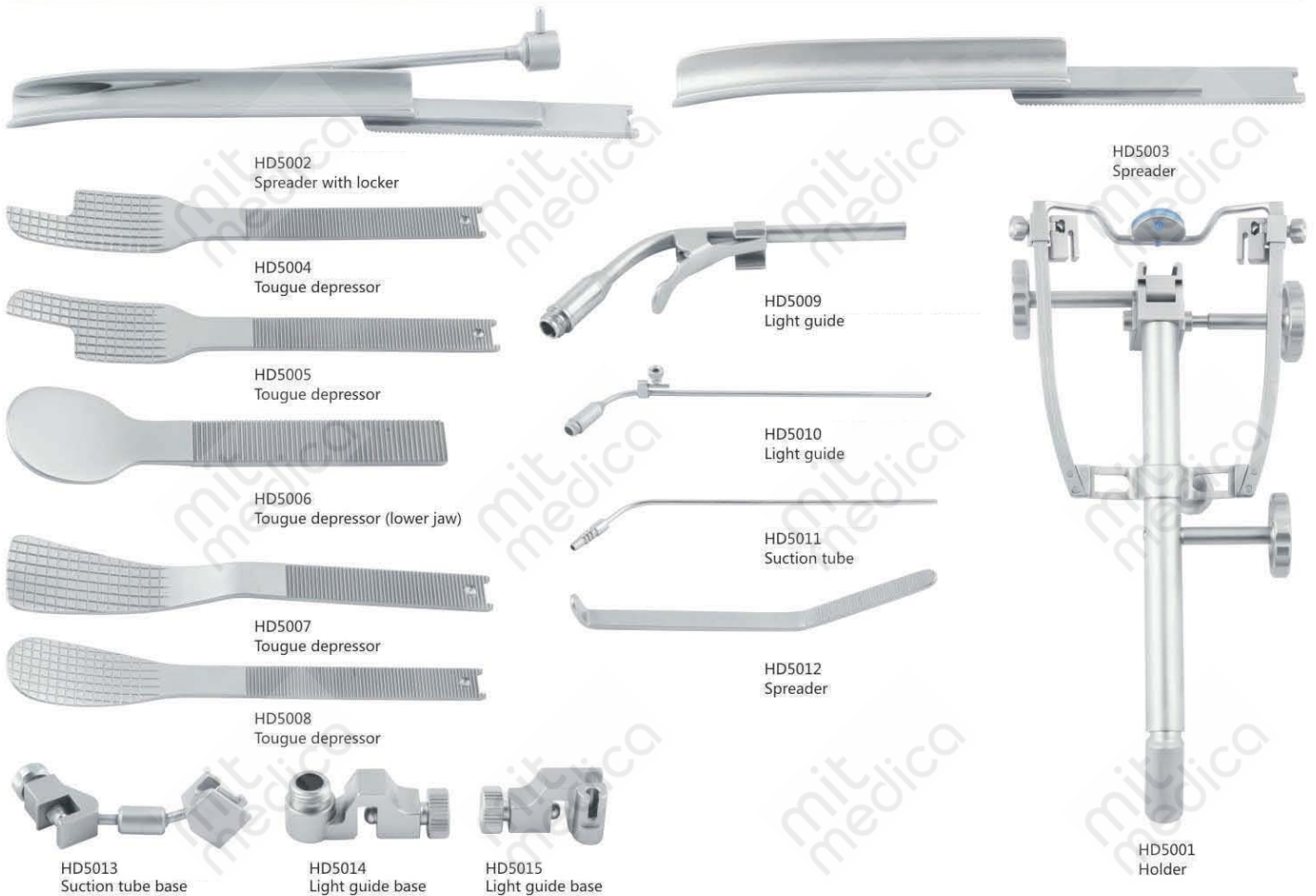

Laryngoscopy Instruments



HD2052 Mouth-gag (5×1)



Jenning mouth gag
HD2075 (L)
HD2075.1 (M)
HD2075.2 (S)



HD2052.1
Proboscis anesthetic mouth-gag
(4×1)



HD2053
Mouth-gag,
with water nozzle
(5×1)



HD2053.1
Mouth-gag, with fiber (5×1)



HD2053.3
Mouth-gag, frame (4×1)



HD2044
Tonsil guillotine, three heads



HD2056
Tonsil snare, bayonet shaped

Laryngoscopy Instruments



HD2070
Indirect laryngeal forceps
One handle with three jaws, rotating head 260mm



HD2055
Laryngeal pustule cutting forceps
With suction & irrigation



260mm
Fish bone catching forceps
HD2035 Open to front
HD2036 Open to left
HD2037 Open to right
HD2038 Open to back
HD2039 Rotating head
HD2040 Open to left & right



260mm
Polyp forceps of vocal cord
HD2021 Rotating head
HD2022 Open to front
HD2023 Open to back
HD2024 Open to left
HD2025 Open to right



45° 260mm
Special polyp forceps of vocal cord
HD2026 Open to front
HD2027 Open to back
HD2028 Open to left
HD2029 Open to right



260mm
Special laryngeal forceps
HD2030 Rotating head
HD2031 Upward
HD2032 Downward
HD2033 Leftward
HD2034 Rightward



HD2042
Laryngeal pustule cutting forceps
Open to left & right 260mm



HD2041
Laryngeal scissors



Indirect laryngeal forceps
HD2071 Open to left
HD2072 Open to right
HD2073 Open to up
HD2074 Open to down



Indirect laryngeal forceps
HD2071.1 Open to left
HD2072.1 Open to right
HD2073.1 Open to up
HD2074.1 Open to down



Fish bone catching forceps, new type 260mm
HD2040.1 Curved, open to up
HD2040.2 Open to left



HD1009.2
Laryngoscope blade 100mm



HD1010.2
Laryngoscope blade 130mm



HD1009.1
Laryngoscope blade 112mm



HD1010.1
Laryngoscope blade 132mm



HD1008.2
Laryngoscope blade 92mm



HD1008.1
Laryngoscope blade 92mm



HD1007.2
Laryngoscope blade 80mm



HD1007.1
Laryngoscope blade 77mm

HT5007.2
Minitype light source

HT5007.1
Minitype light source

MYJ-3
Anesthetic laryngoscope, with lamp

MYJ-2
Anesthetic laryngoscope, fiber optic

Laryngoscopy Instruments



HD2057
Tonsil gland scissors



HD2068
Thyroid scissors 180mm



Tonsil hemostat 180mm
HD2060 Micro curved
HD2061 Angled curved



Tonsil holding forceps 220mm
HD2058 Angled with 3 claws
HD2059 Angled with teeth



HD2089
Tongue grasping forceps 170mm



Tonsil sponge forceps 180mm
HD2062 Straight channel
HD2063 Curved channel
HD2062.1 Straight no channel
HD2063.1 Curved no channel



HD2064
Tonsil elevator



HD2067
Tonsil retractor, elevator, double heads



Tonsil retractor
HD2065 2 claws, blunt head
HD2065.1 2 claws, sharp head



HD2066
Tonsil knife



HD2095
Thyroid retractor, double heads



HD2043
Laryngeal polyp snare



HD2087
Tonsil needle, curved



HD2088
Tonsil needle, straight

Laryngoscopy Instruments

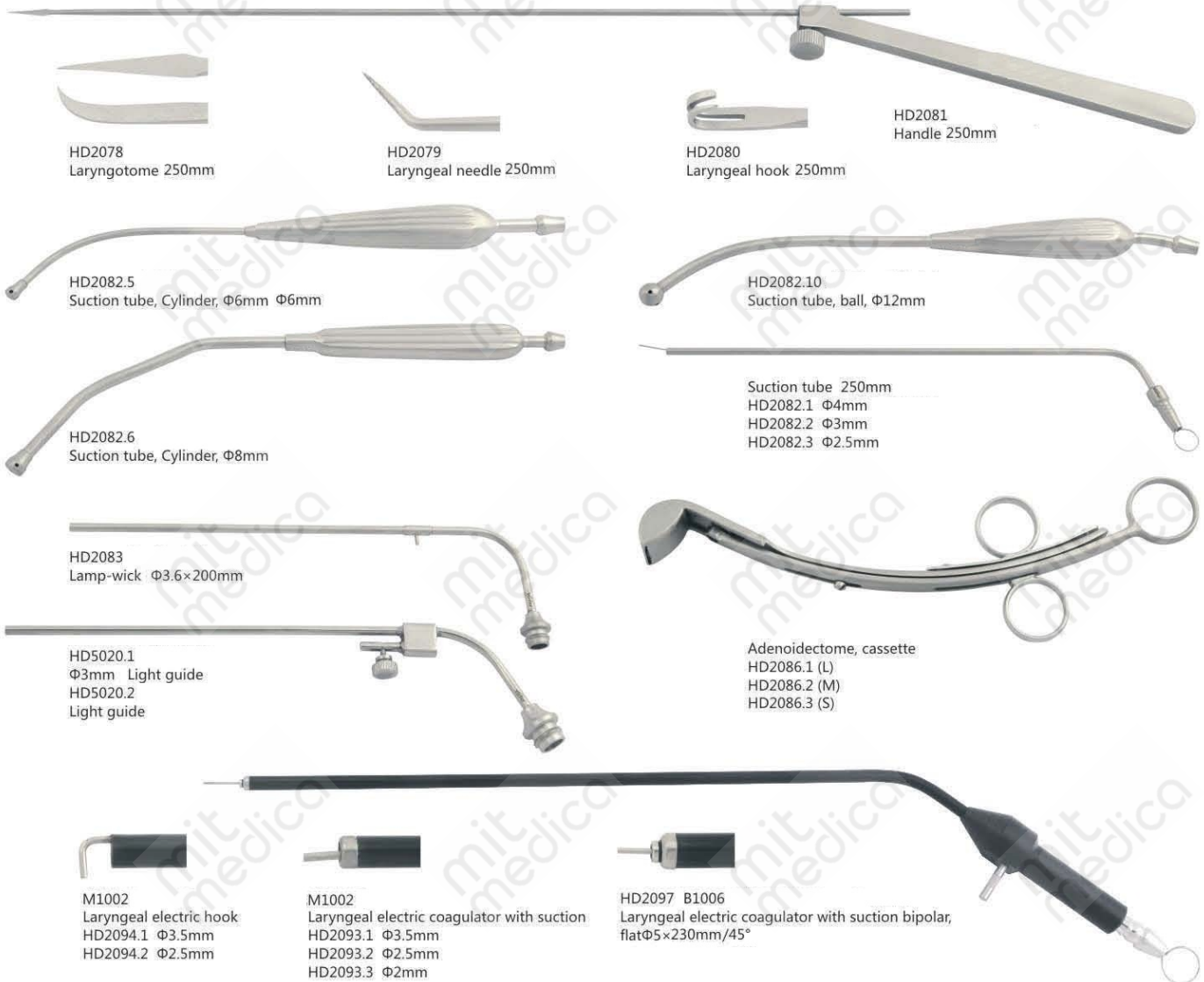

Bronchoscopy instruments



Bronchoscopy instruments

Pediatric bronchoscopy visual tube

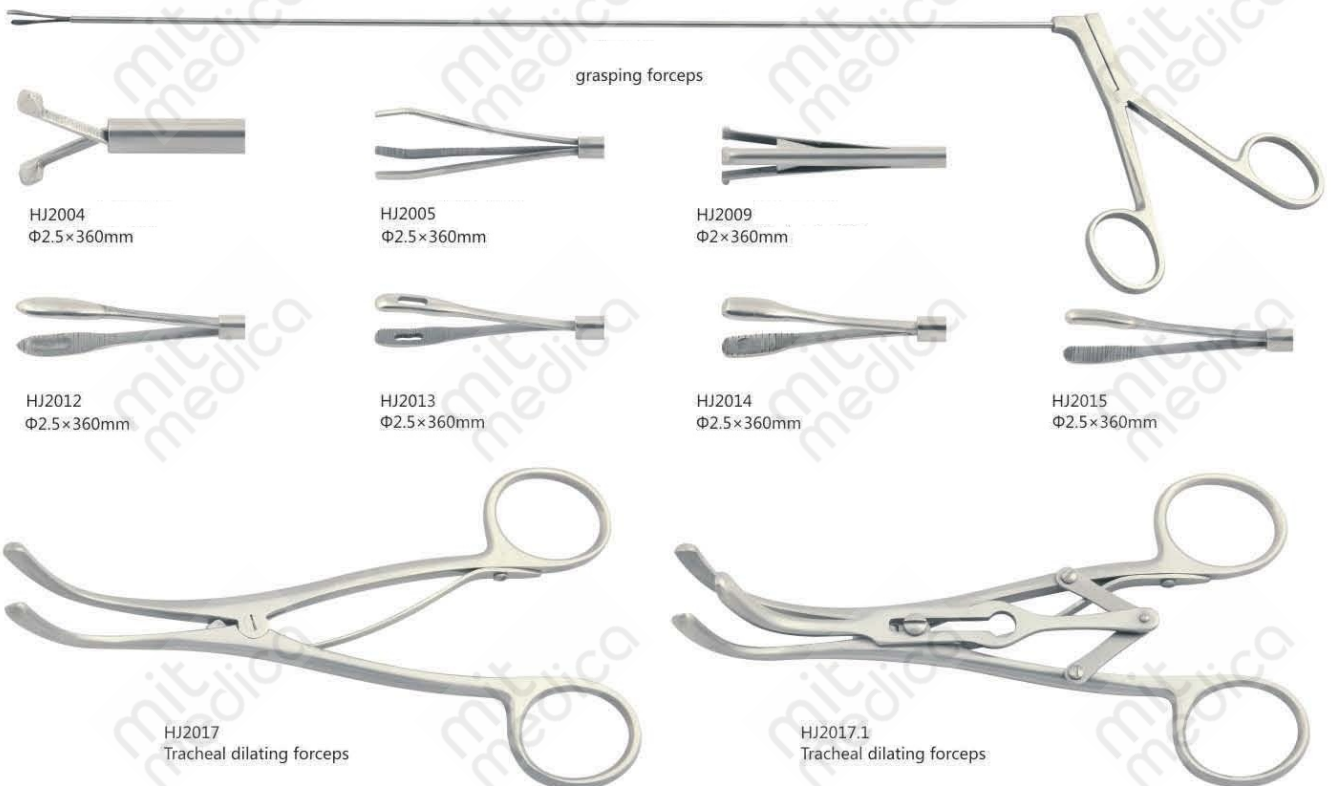

Bronchoscopy instruments

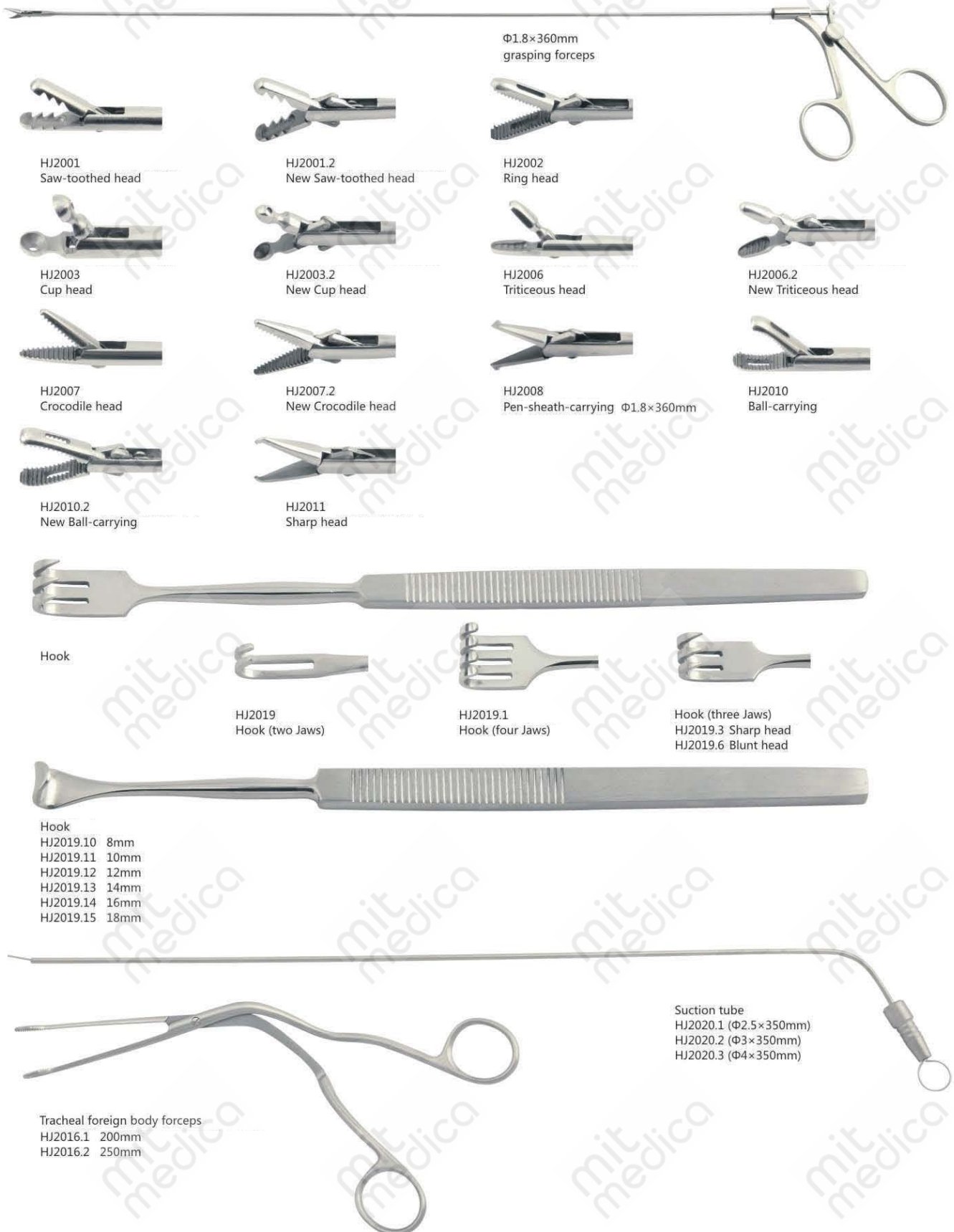

Bronchoscopy instruments



Tracheal tube

HJ1001.1 (4mm)
HJ1001.2 (5mm)
HJ1001.3 (6mm)
HJ1001.4 (7mm)
HJ1001.5 (8mm)
HJ1001.6 (9mm)
HJ1001.7 (10mm)
HJ1001.8 (11mm)
HJ1001.9 (12mm)
HJ1001.10 (13mm)



Trigeminal tracheal tube

HJ1002.1 (4mm)
HJ1002.2 (5mm)
HJ1002.3 (6mm)
HJ1002.4 (7mm)
HJ1002.5 (8mm)
HJ1002.6 (9mm)
HJ1002.7 (10mm)
HJ1002.8 (11mm)
HJ1002.9 (12mm)



Single tube of total throat

HJ1003.1 (9mm)
HJ1003.2 (10mm)
HJ1003.3 (11mm)
HJ1003.4 (12mm)
HJ1003.5 (13mm)
HJ1003.6 (14mm)



Double tube of total throat

HJ1004.1 (9mm)
HJ1004.2 (10mm)
HJ1004.3 (11mm)
HJ1004.4 (12mm)
HJ1004.5 (13mm)
HJ1004.6 (14mm)

Esophagoscopy instruments



Esophagoscopy visual tube

HK1001 8×10×200mm
HK1001.1 7.5×10×200mm
HK1001.2 8×11×180mm
HK1002.1 10×12×250mm
HK1002.2 10×12×300mm
HK1003.1 12×14×300mm
HK1003.2 12×14×350mm
HK1004 14×16×400mm



Esophagoscopy visual tube, with fiber inside

HK1005 9×13×250mm
HK1006 11×15×300mm
HK1007.1 10×16×360mm
HK1007.2 10×16×400mm
HK1008 13×17×380mm
HK1009.1 12×18×250mm
HK1009.2 12×18×400mm
HK1009.3 12×18×450mm



Hk1000
handle



HK2014
Spatula, straight



HK2015
Spatula, angled

Esophagoscopy instruments

Esophageal grasping forceps



HK2001.1 $\Phi 4 \times 350\text{mm}$
 HK2001.2 $\Phi 4 \times 450\text{mm}$
 HK2004.1 $\Phi 4 \times 380\text{mm}$
 HK2004.2 $\Phi 4 \times 450\text{mm}$
 HK2004.3 $\Phi 4 \times 500\text{mm}$



HK2002.1 $\Phi 4 \times 350\text{mm}$
 HK2002.2 $\Phi 4 \times 450\text{mm}$
 HK2003.1 $\Phi 4 \times 380\text{mm}$
 HK2003.2 $\Phi 4 \times 450\text{mm}$
 HK2003.3 $\Phi 4 \times 500\text{mm}$



HK2005.1 $\Phi 4 \times 380\text{mm}$
 HK2005.2 $\Phi 4 \times 450\text{mm}$
 HK2005.3 $\Phi 4 \times 500\text{mm}$



HK2006.1 $\Phi 4 \times 380\text{mm}$
 HK2006.2 $\Phi 4 \times 450\text{mm}$
 HK2006.3 $\Phi 4 \times 500\text{mm}$



Esophageal biopsy forceps



HK2007
 Esophageal biopsy forceps
 Left curved $\Phi 3.4 \times 450\text{mm}$



HK2008
 Esophageal biopsy forceps
 Right curved $\Phi 3.4 \times 450\text{mm}$



HK2009
 Esophageal biopsy forceps
 Rotatable $\Phi 3.4 \times 450\text{mm}$



HK2010
 Esophageal polyp forcep Straight
 $\Phi 3.4 \times 450\text{mm}$



HK2012.1
 Esophageal polyp forceps
 Cup head $\Phi 4 \times 380\text{mm}$ 45°



HK2012.2
 Esophageal polyp forceps
 Right curved $\Phi 4 \times 450\text{mm}$

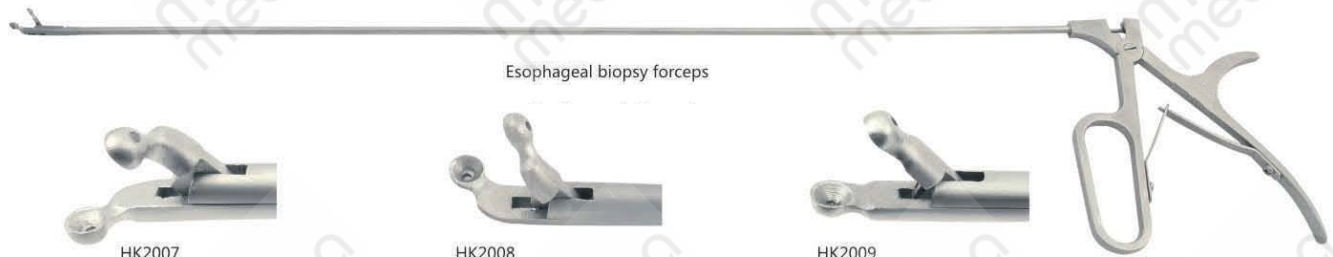

HK2011
 Esophageal scissor Straight
 $\Phi 3.4 \times 450\text{mm}$



Hk2013
 Esophageal biopsy forceps
 $\Phi 4 \times 380\text{mm}$



Suction tube
 HK2016.1 $\Phi 4 \times 450\text{mm}$
 HK2016.2 $\Phi 3 \times 450\text{mm}$
 HK2016.3 $\Phi 2.5 \times 450\text{mm}$



Neuroendoscopy instruments



Ventriculoscope $\Phi 2.7 \times 205\text{mm}$
 HN0010 0°
 HN0011 30°



HN1003
 Endoscope holder



Hn1101
 Working sheath 21.9Fr

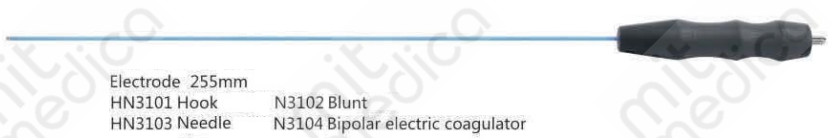

Electrode 255mm
 HN3101 Hook N3102 Blunt
 HN3103 Needle N3104 Bipolar electric coagulator



Suction tube 170mm
 HN2105.1 $\Phi 2.5\text{mm}$
 HN2105.2 $\Phi 3.0\text{mm}$
 HN2105.3 $\Phi 3.5\text{mm}$
 HN2105.4 $\Phi 4.0\text{mm}$
 HN2105.5 $\Phi 5.0\text{mm}$



HN2101
 Micro scissors, sharp, flexible $\Phi 2 \times 300\text{mm}$



HN2103
 Micro biopsy forceps, flexible $\Phi 2 \times 300\text{mm}$



HN2102
 Micro scissors, blunt, flexible $\Phi 2 \times 300\text{mm}$



Hn2104
 Micro grasping forceps, 3 claws flexible $\Phi 2 \times 300\text{mm}$



Basic Surgical Instruments



HY2001.6
Needle holder, straight with lock 18cm



HY2006
Scissor for eyes, Curved, Sharp head 10cm



HY2005
Scissor for eyes straight, Sharp head 10cm



Scissor, straight, sharp head
HY2007.1 length 14cm
HY2007.2 length 16cm
HY2007.3 length 18cm



HY2007.23
Tissue scissor, straight, half round 14cm



Tissue forceps Elis head
HY2008.1 width 5cm, length 14cm
HY2008.2 width 5cm, length 16cm



Hemostatic forceps Curved, full tooth
HY2011.1 length 12.5cm
HY2011.2 length 14cm
HY2011.3 length 16cm
HY2011.4 length 18cm
HY2011.5 length 20cm
HY2011.6 length 22cm



HY2016.6
Sponge forceps, Curved toothed
12mm, 25cm



Alloy needle holder
HY2003.6 14cm Straight, gold-plating
HY2003.7 15cm Straight, gold-plating



Tissue scissor Straight, blunt head
HY2007.10 length 20cm
HY2007.11 length 19cm
HY2007.12 length 17cm
HY2007.13 length 14cm



Tissue scissor, Curved, half round
HY2007.28 length 14cm
HY2007.30 length 17cm



Hemostatic forceps Curved,
straight, full tooth
HY2010.1 length 12.5cm
HY2010.2 length 14cm
HY2010.3 length 16cm
HY2010.4 length 18cm
HY2010.5 length 20cm
HY2010.6 length 22cm



Towel forceps, Sharp head
HY2013.1 length 11cm
HY2013.2 length 14cm
HY2013.3 length 16cm



HC2100 Fascia presser



HY2001 Micro needle holder forceps



Needle holder
HY2003.1 14cm Sewation
HY2003.2 14cm Sewation
HY2003.3 14cm Sewation



HY2020.1 125mm Tweezers, Straight
HY2020.5 125mm Tweezers, Straight with hook



HC2049 160mm
HC2049.1 200mm
HC2049.2 160mm head with hook
HC2049.3 195mm head with hook
HC2049.4 180mm head with hook
HC2049.6 180mm

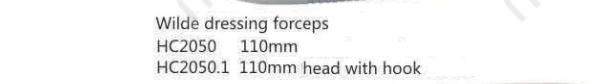

Wilde dressing forceps
HC2050 110mm
HC2050.1 110mm head with hook



HY3001.1 Handle 12.5cm



HY3001.4 Handle (with L blade) 13.5cm



HY3001.7 Handle 12.5cm



Tuning forks
HC2036.1 128
HC2036.2 256



Tuning forks
HC2036.3 512
HC2036.5 2048

HC2036.4 1024
HC2036.6 4096



HC1001.1
Ear speculum $\Phi 3$, $\Phi 4$, $\Phi 5$ 3pcs/set

Endoscopy imaging



EI-2000 Imaging unit

1. Endoscope camera: SY-HD901 (FULL HD)
2. Medical monitor: 24" (HD 1080P)
3. Medical LED light source: SY-L203
4. Light guide cable: 2.5m
5. Remote control service system: supply remote repairs
6. Remote control service host: SY-G301 (included workstation)
7. Printer: HP 1010
8. Trolley: with arm rest, save space, match with Samsung monitor



FNT-500 Imaging system

1. CCD : F-168D 1-chip 600 lines
2. Monitor : 22 inch, 16:9, touchable
3. Printer : inkjet
4. Process host
5. Image acquisition board : 32 bite full color
6. Image acquisition controller : footswitch
7. Cart : assembly-disassembly , metal plate
8. Cold light source : XD-250
9. Software : endoscopy imaging program
10. Light cable : $\Phi 4.5\text{mm} \times 2500\text{mm}$



FNT-800 Imaging unit

1. CCD : F-368D 3-chips , 800 lines
2. Monitor : 24 inch
3. Cart : assembly-disassembly , metal plate
4. Cold light source : LED300
5. Light cable : $\Phi 4.5\text{mm} \times 3000\text{mm}$

FNT-1000 Imaging unit

1. CCD : HD380 3-chips 1920×1080
2. Monitor : 24 inch
3. Cart : assembly-disassembly , metal plate with arm
4. Cold light source : LED300
5. Light cable : $\Phi 3.5\text{mm} \times 300\text{cm}$

FNT-400 Imaging unit

1. CCD : F-168D 1-chip , 600 lines
2. Monitor : 19 inch
3. Cart : assembly-disassembly , metal plate
4. Cold light source : LED300
5. Light cable : $\Phi 4.5\text{mm} \times 2500\text{mm}$

Coupler

Coupler, Straight



Code	Focal length
HA2513.1	F18
HA2512.3	F22
HA2513.3	F25
HA2512.1	F27
Ha2517	F28
HA2512.5	F32
HA2512.6	F35

Cold light source



Ht5002 350w xenon
HT5040 LED



HT5007.6
Portable cold light source (with charger)

Sterilized case of instruments



HA0000.1
For Cystoscopy set
530×230×90mm



HA0000.2
For Resectoscope set
420×275×90mm



HB0000.3
For Sinuscopy instruments
380×210×70mm



HB0000.2
For Sinuscopy set
360×255×90mm



Hf0000
For powered hystera-cutter
560×275×140mm



H190001000
Endoscope Instruments in common use
550×245×70mm



H190001000a
Endoscope Instruments in common use
550×245×70mm



HB0000
For endoscope
280×70×50mm



HB0000.5
For endoscope, autoclavable
255×71×36mm



HE0000
For laparoscope
450×90×45mm



HB0000.4
For endoscope
550×250×100mm



HA0000.4
For endoscope, autoclavable
390×71×36mm